

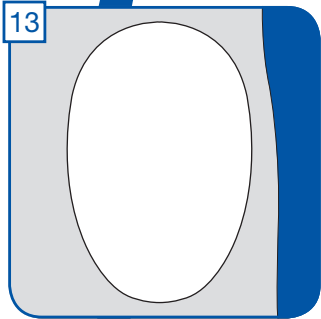

13



A

14

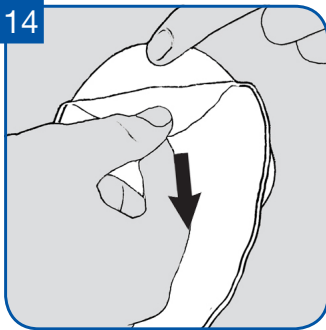

15

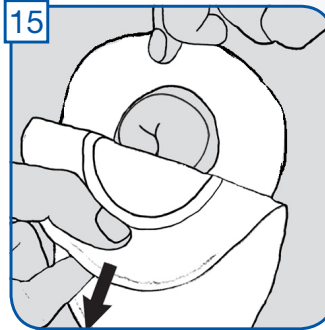

16



17

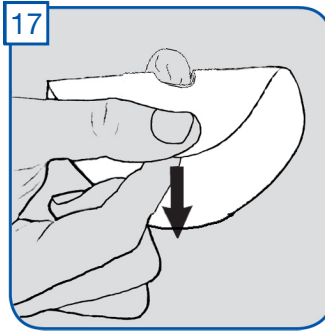

18



B

14

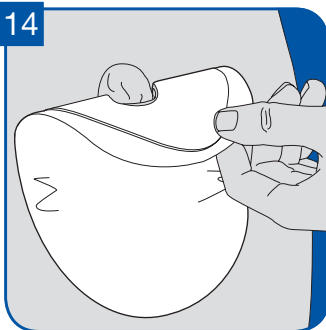

15



Welland Medical Ltd.,
Hydehurst Lane, Crawley,
West Sussex RH10 9AS
United Kingdom

Tel: +44 (0) 1293 615455
Fax: +44 (0) 1293 615411
Email: info@wellandmedical.com
(A CliniMed Group Company)

PPR-INS-A18

PID 1778 Welland® and the Welland logo™ are trade marks of CliniMed (Holdings) Ltd.

www.wellandmedical.com

INVESTORS IN PEOPLE Gold



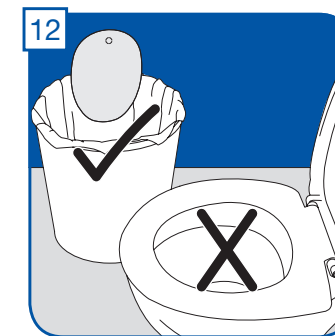
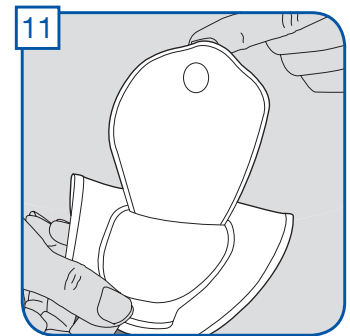
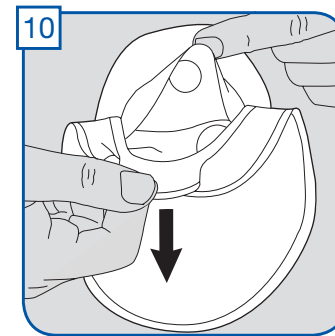
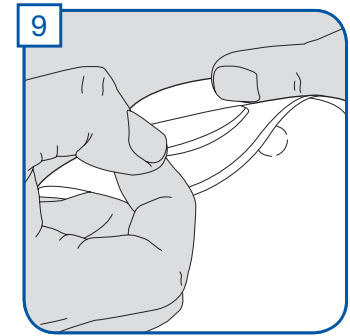
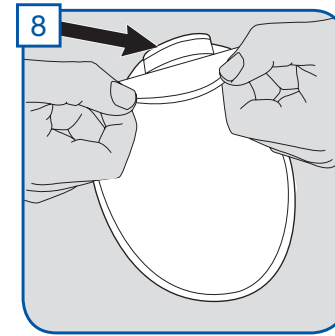
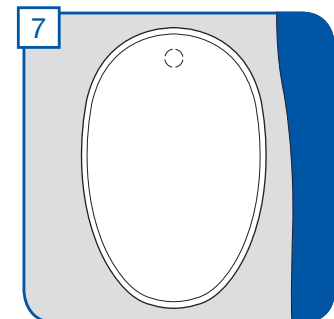
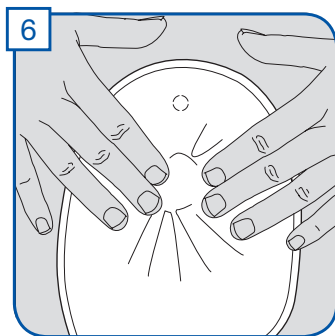
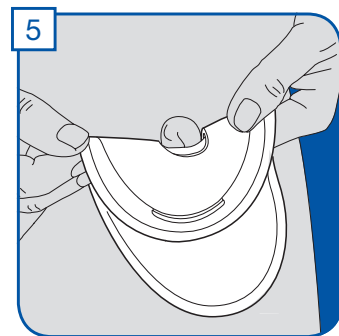
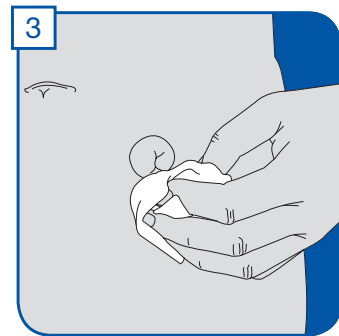
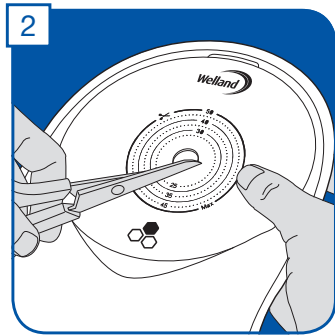
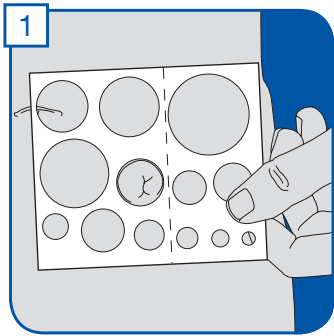

EN Contains Manuka Honey
 DE Enthält Manuka-Honig
 NL Bevat manukahoning
 IT Contiene miele di Manuka
 SE Innehåller Manuka honung
 DA Indeholder Manuka honning
 NO Indeholder manukahonning
 ES Contiene miel de Manuka

FI Sisältää manukahunajaa
 FR Contient du miel de Manuka
 CS Obsahuje manukový med.
 RO Conține miere de Manuka
 PT Contém mel de Manuka
 PL Zawiera miód manuka
 LT Sudėtyje yra manuka medaus
 LV Satur manuka medu

EL Περιέχει μέλι Μανούκα
 AR تحتوي على عسل المانوكا
 HI मनुका हनी युक्त
 EL Sisaldab manuka mett
 RU Содержит мед чайного
 дерева